

125C FLATUS 125

150CC FLATUS 150



工具箱



1	125T-18-050600	Foot plate	1
2	125T-18-050501	Tool box	1
3	125T-18-050503	Tool box cover	1
4	125T-18-050004		1
5	125T-18-050504	Tool box rocker	1
6	125T-18-000007	Motorcycle safety helmet pothook	1
7	125T-18-050502		1
8	125T-18-050201	L protect piece	1
9	125T-18-050202	R protect piece	1

杂物箱



1	125T-18-002000	Seat groupware (red)	1
2	125T-18-050001	Sundries box	1
3	125T-18-050002	sundries box inner cover	1
4	125T-18-050003	Sundries box fr cover	1

前大板

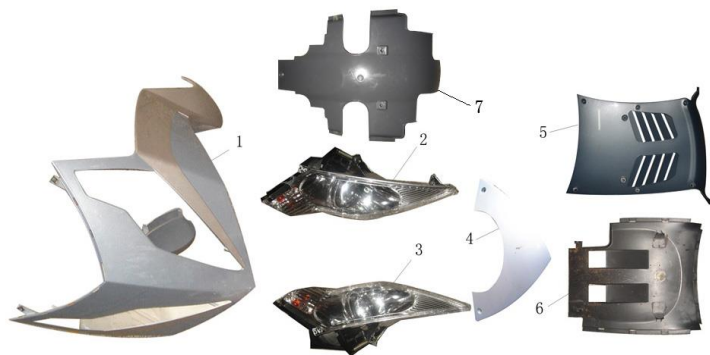

1	125T-18-050101	Fr board	1
2	125T-18-050102		1
3	125T-18-050103		1
4	125T-18-050104		1
5	125T-18-050401	frame fender up	1
6	125T-18-050402	frame fender down	1
7	125T-18-030007	back wheel fender	1

油箱

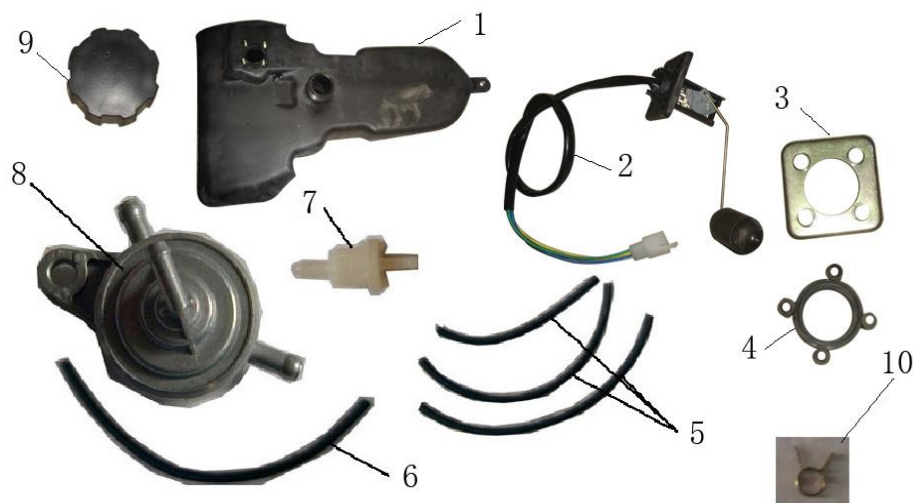

1	125T-18-060100	Fuel tank	1
2	125T-18-060101	Oil digit sensor	1
3	125T-18-060102.1	Sensor press board	1
4	125T-18-060102.2	Sensor airproof circle	1
5	125T-18-060001	Gasoline pipe	3
6	125T-18-060003	Vacuum tube	1
7	125T-18-060105	filter	1
8	125T-18-060103	Self-priming switch	1
9	125T-18-060104	Cover, gasoline tank	1
10	125T-18-060002	Circlip	6

装饰板

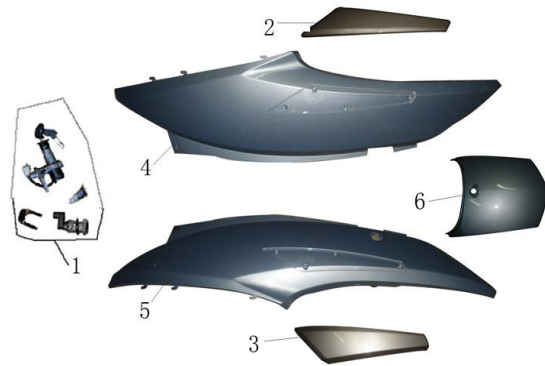

1	125T-18-030001	Key Set Comp.	1
2	125T-18-050303	left decorate piece	1
3	125T-18-050304	right decorate piece	1
4	125T-18-050301	left decorate board	1
5	125T-18-050302	right decorate board	1
6	125T-18-050700	Rr decorate board	1

后尾板



1	125T-18-050900	Rr taillight (with l/r/r turning light)	1
2	125T-18-050804	Side reflector	2
3	125T-18-050803	Rr license plate bracket	1
4	125T-18-050801	Rr trail board	1
5	125T-18-050802	Rr refelctor	1
6	125T-18-050805		1

后扶手



1	125T-18-003000	Luggage carrier	1
---	----------------	-----------------	---



电瓶

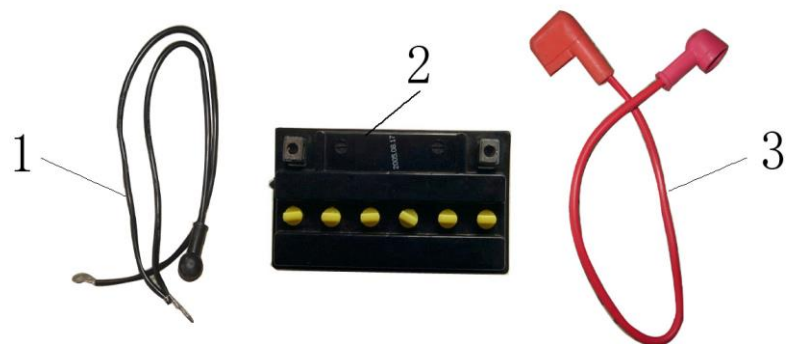

1	125T-18-070005	Cathode line	1
2	125T-18-070400	Battery assy	1
3	125T-18-070006	Anode line	1

主电缆

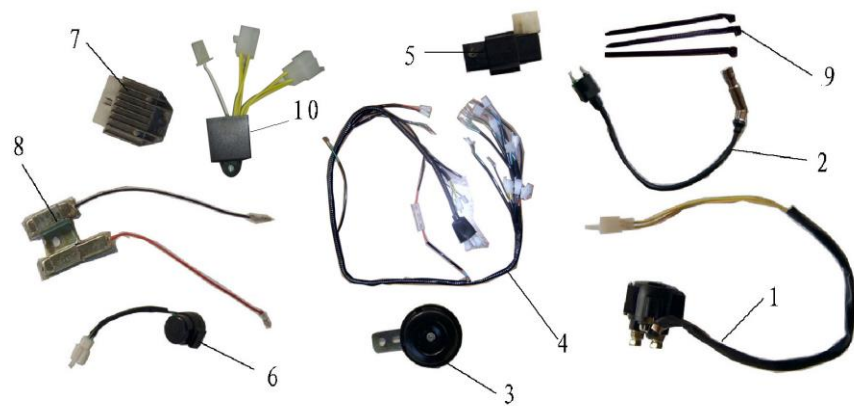

1	125T-18-070100	Start-up relay	1
2	125T-18-070200	Ignition loop	1
3	125T-18-070300	horn	1
4	125T-18-070001	cable	1
5	125T-18-070002	ignition	1
6	125T-18-070003	flasher	1
7	125T-18-070004	manostat	1
8	125T-18-070007	resistance	1
9	125T-18-090010	wrap	1套
10	125T-18-070008		1

前轮组件



1	125T-18-010201	Fr al wheel (red)	1
2	125T-18-010202	Vacual tire	1
3	125T-18-010203	Value mouth	1
4	125T-18-010204	Disc brake plate	1
5	125T-18-010205	Disc brake plate bolt	5
6	125T-18-010002	Front-wheel drive axle	1
7	GB6177-86	M12X1.25 locknut	1
8	125T-18-010400	driver	1
9	125T-18-020202	Odometer gentle axis	1
10	125T-18-010001	Front axle	1
11	125T-18-010201.1	Dust seal	1
12	GB276-64	Bearing	2
13	125T-18-010201.2	Fr wheel axle, collar	1
14	125T-18-010201.3	front-wheel hub	1

后轮组件

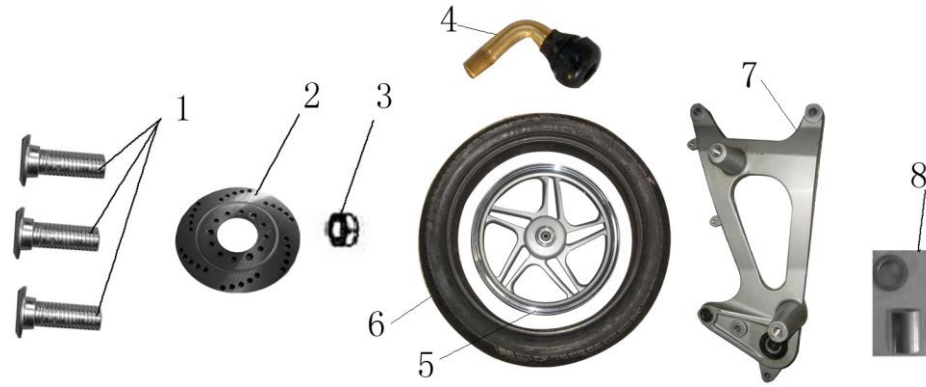

1	125T-18-041001	Rr disc brake plate bolt	1
2	125T-18-041000	Rr disc brake palte	1
3	GB5787-86	Six corner nut M16X1.5	1
4	125T-18-010203	Vavle mouth	1
5	125T-18-040500	Rr al wheel (red)	1
6	125T-18-040600	Vacunnm tire	1
7	125T-18-040700	Three corner connection board	1
8	125T-18-040003	Rr wheel bush (ling, short)	各1

后制动手柄组件

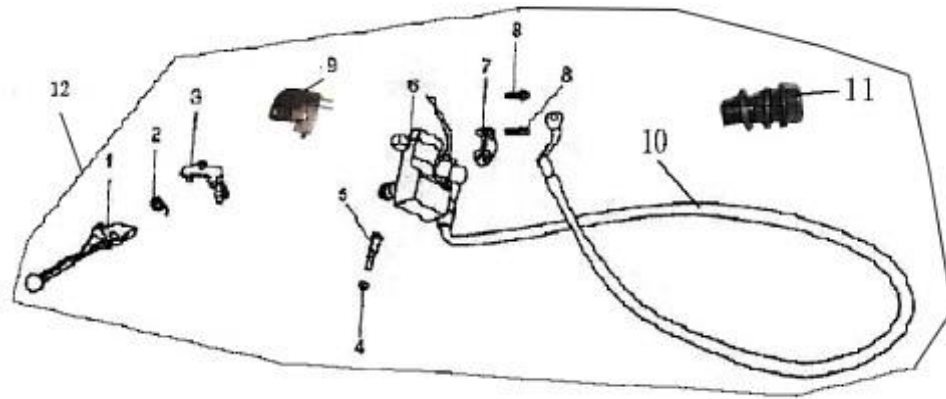

1	125T-18-040901.1	Grip comp handle L	1
2	125T-18-040901.2	Retuming spring	1
3	125T-18-040901.3	Connecting socket	1
4	125T-18-040901.4	Nut M5	1
5	125T-18-040901.5	Bolt comp handle L	1
6	125T-18-040901.6	Oil cylinder ,Fr brake comp	1
7	125T-18-040901.7	Semicircle cap	1
8	125T-18-040901.8	Bolt M6X22	2
9	125T-18-040901.9	Switch, front stop	1
10	125T-18-040901.10	oil pipe	1
11	125T-18-040901.11	bolt,oil inlet	2
12	125T-18-040901.12	Rr disc brake pump	1

后制动下泵组件

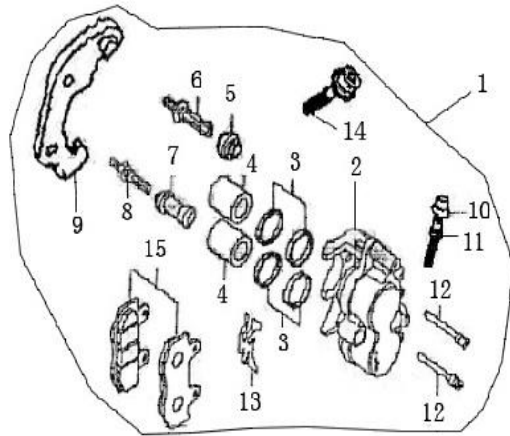

1	125T-18-040902	Rr disc brake pump	1
2	125T-18-040902.1	Oil cylinder	1
3	125T-18-040902.2	dustproof set piece	2
4	125T-18-040902.3	oil crotch pin	2
5	125T-18-040902.4	bolt pin glue circle	1
6	125T-18-040902.5	bolt pin A	1
7	125T-18-040902.6	bolt pin bush	1
8	125T-18-040902.7	bolt pin	1
9	125T-18-040902.8	disc brake pump decorate board	1
10	125T-18-040902.9	Cover	1
11	125T-18-040902.10	Bolt of exhaust	1
12	125T-18-040902.11	orientation bolt pin	2
13	125T-18-040902.12	diaplasis spring	1
14	125T-18-040902.13	bolt,oil inlet	1
15	125T-18-040902.14	Rear trig disc brake piece	1

仪表组件



1	125T-18-020201	speedometer groupware	1
---	----------------	-----------------------	---

方向把组件



1	125T-18-020101	left hand glove	1
2	125T-18-020103	L combination switch	1
3	125T-18-001001	left rearview mirror	1
4	125T-18-020104	Direction hand	1
5	125T-18-020107	windshield	1
6	125T-18-020108	speedometer cover	
7	125T-18-020106	Accelerograph cable	1
8	125T-18-020102	right hand glove	1
9	125T-18-020105	R combination switch	1
10	125T-18-001002	right rearview mirror	1
11	125T-18-000006	windshield	1



前制动手柄组件

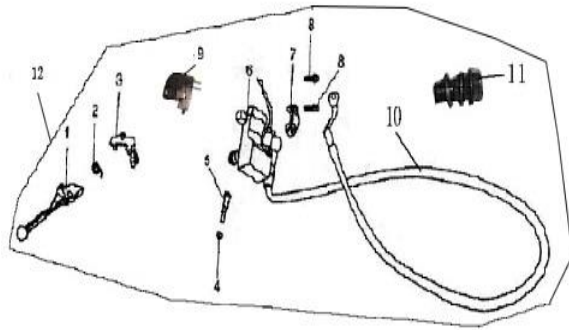

1	125T-18-010301.1	Grip comp handle R	1
2	125T-18-010301.2	Returning spring	1
3	125T-18-010301.3	Connecting socket	1
4	125T-18-010301.4	Nut M5	1
5	125T-18-010301.5	Bolt comp handle R	1
6	125T-18-010301.6	Oil cylinder ,Fr brake comp	1
7	125T-18-010301.7	Semicircle cap	1
8	125T-18-010301.8	Bolt M6X22	2
9	125T-18-010301.9	Switch, front stop	1
10	125T-18-010301.10	oil pipe	1
11	125T-18-010301.11	bolt,oil inlet	2
12	125T-18-010301	Fr disc brake pump	1

前制动下泵组件

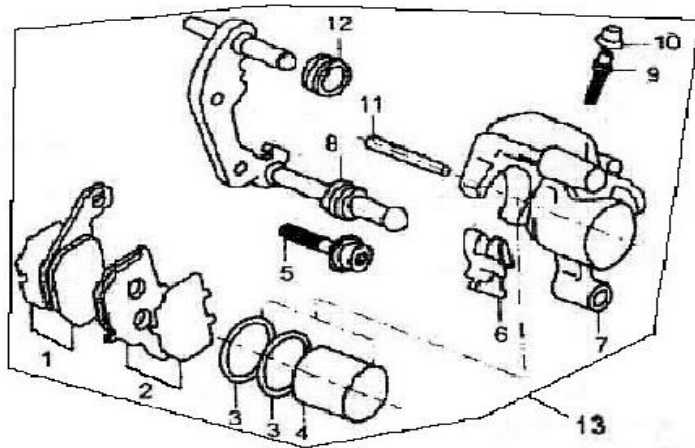

1(2)	125T-18-010302.1	Disc brake piece	2
3	125T-18-010302.2	Oil seal	2
4	125T-18-010302.3	piston	1
5	125T-18-010302.4	Apply the brake clamp bolt	1
6	125T-18-010302.5	shrapnel	1
7	125T-18-010302.6	Assistant cylinder	1
8	125T-18-010302.7	insulator	1
9	125T-18-010302.8	Exhaust bolt	1
10	125T-18-010302.9	cover	1
11	125T-18-010302.10	pin	2
12	125T-18-010302.11	Protect cover	1
13	125T-18-010302	Fr disc brake pump	1

发动机&附件



1	125T-18-040100	engine(red)	1
	150T-18-040101		1
2	125T-18-040200	carburetor	1
	150T-18-040201		1
3	125T-18-040400	Air filter groupware	1
4	125T-18-040401	air filter frame	1
5	125T-18-040002	Air cleaner holder, air pipe	1
6	125T-18-040400.1	sponge in air filter	1

后减震器

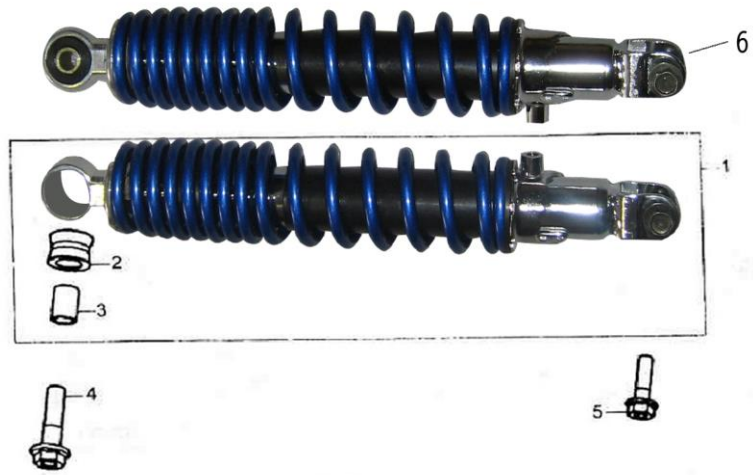

1	125T-18-040301	L rear absorber (red)	1
2	125T-18-040301.1	absorber cushion gasket	2
3	125T-18-040301.2	absorber bush	2
4	GB5787-86	Bolt flange M10X40	2
5	GB5787-86	Bolt flange M8X30	2
6	125T-18-040302	R rear absorber (red)	1

前叉组件



1	125T-18-010101	Down connection groupware	1
2	125T-18-010102	l/ fr absorber assembly	1
3	125T-18-010103	r/fr absorber assembly	1
4	125T-18-010004.1	Fixing block	1
5	125T-18-010004.2	Line set	1
6	125T-18-010005		2
7	GB5789-86	Six corner bolt M8X40	4
8	125T-18-010003	Fr fender (red)	1
9	125T-18-000002	Down axletree groupware	1
10	125T-18-000001	Up axletree groupware	1
11	125T-18-000003	Compaction nut	1

消声器总成

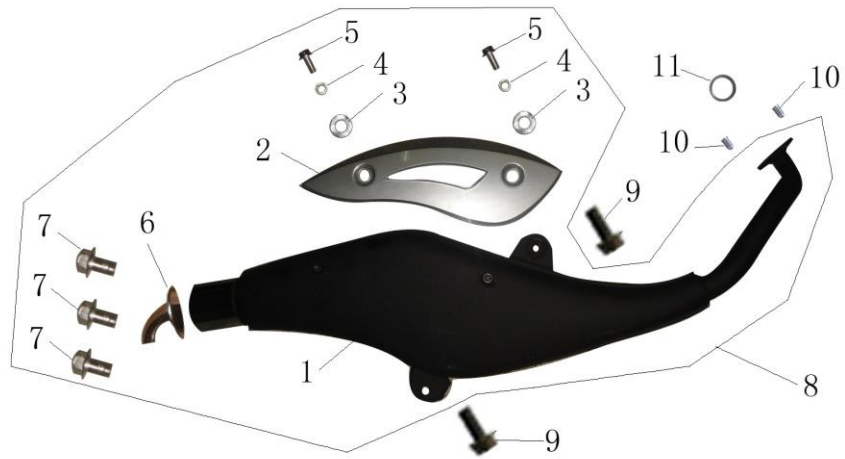

1	125T-18-040801	Muffler	1
2	125T-18-040802	Protecting plate	1
3	125T-18-040803		2
4	125T-18-040804		2
5	GB5787-86	Six corner bolt M6X20	2
6	125T-18-040805		1
7	GB5787-86	Six corner bolt M6X12	3
8	125T-18-040800	Muffler assembly	1
9	GB5787-86	Six corner bolt M10X25	2
10	GB823-86	Long cover nut M6	2
11	125T-18-040001	Muffler airproof gasket	1

支架组件

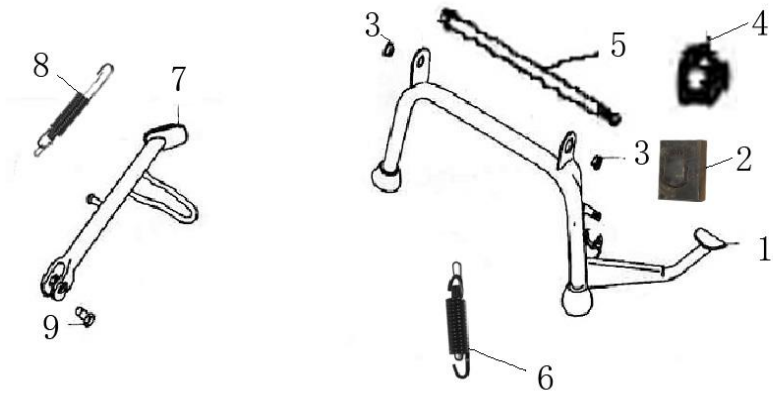

1	125T-18-041100	main stand comp	1
2	125T-18-040005	rubber, main stand	1
3	125T-18-040004	big support bush	2
4	GB6187-86	Bolt flange M10	1
5	125T-18-040006		1
6	125T-18-040007	Big support spring	1
7	125T-18-030400	side stand	1
8	125T-18-030003	Single support spring	1
9	125T-18-030002	Big support bolt	1

车架及附

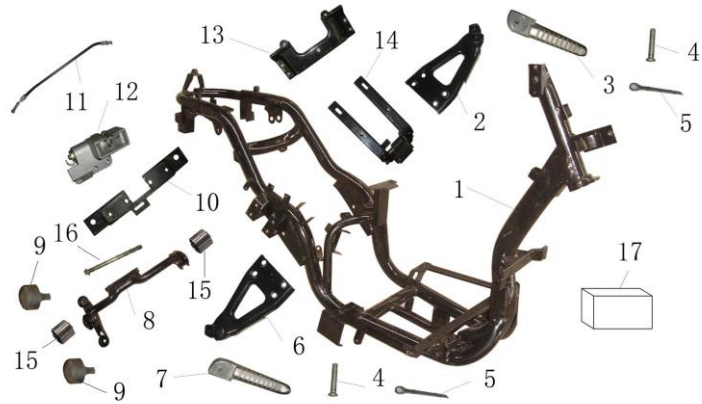

1	125T-18-030100	frame	1
2	125T-18-030301		1
3	125T-18-030303	L foot	1
4	125T-18-030305.1		2
5	125T-18-030305.2		2
6	125T-18-030302	luggage carrier bracket	1
7	125T-18-030304	R foot	1
8	125T-18-030500	hang groupware	1
9	125T-18-030005	hanger rubber	2
10	125T-18-030601		1
11	125T-18-030602	seat lock cable	1
12	125T-18-030600	seat lock bracket	1
13	125T-18-030006	bracket, fuel tank	1
14	125T-18-030200		1
15	125T-18-030004	hanger bush	2
16	125T-18-000005	hang frame axes	1
17	125T-18-080000	whole standard accessory	1
18	125T-18-090020	tools with motorcycle	1